

1. GENERAL DESCRIPTION / 概要

(1) Features / 特徴

CRS09 is a solid-state single-axis rate sensor which utilizes the proven silicon vibrating structure gyroscope (Si-VSG®) sensor technology. It is a stand-alone unit which produces an analogue dc voltage output directly proportional to the rate of rotation.

At the core of the gyroscope is an improved micro-machined ring resonator which affords a high degree of resistance to external shocks and vibrations over a wide temperature range.

CRS09 provides excellent scale factor linearity, low noise, and drift performance.

本シリコン振動ジャイロは1軸ソリッドステート角速度センサであり、角速度に比例した直流電圧を出力します。マイクロマシニングのリング型振動子により広い温度範囲で外部衝撃や振動に対し優れた耐性を発揮します。本製品は、非直線性やノイズ、ドリフトで高い性能を示します。

(2) Type / 型式

CRS09-22 (Rate Range : 100deg/s)

Detail of Distinction / 識別詳細

CRS09-22

1 2

1:Series Model Code

/基本製品コード

2:Suffix

/サフィックス

2. MECHANICAL DESCRIPTION / 外形

The nominal dimensions are shown in Fig.1.

図1に外形を記載。

3. CHARACTERISTICS / 性能

	Parameter	Min 最小値	Typ 代表値	Max 最大値	Unit 単位	Notes 備考
Absolute Maximum Ratings 絶対最大定格	Supply Voltage 電源	0.00	5.00	5.50	V	
	Storage Temperature 保存温度	- 40		85	deg C	
	Operational Vibration 動作限界加速度			98	m/sec ²	20 to 2kHz peak to peak
Operating Conditions 動作環境	Supply Voltage 電源	4.75	5.00	5.25	V	
	Power Supply Noise 電源ノイズ			15.00	mVrms	0.5 to 100 Hz
	Temperature 温度	- 20	23	60	deg C	
	Humidity 湿度	5		95	%RH	Not condensing 結露無きこと

The following specifications apply for Vdd=5.00V and Temp=23deg C unless otherwise stated.

Specifications are defined in unit of rad/s or rad/h. Units shown in deg/s or deg/h have been converted for user convenience.

特に指定なき場合下記はVdd=5.00V 温度23℃で規定。仕様はrad/s あるいはrad/hで規定されdeg/sまたはdeg/hは参考値

Parameter 項目	Min 最小値	Typ 代表値	Max 最大値	Unit 単位	Notes 備考
Rate Range 測定範囲		+/- 100.0		deg/sec	
		+/- 1.745		rad/sec	
Scale Factor Error(23degC) 感度誤差(23℃)	19.80	20.00	20.20	mV/deg/sec	
	1134.5	1145.9	1157.4	mV/rad/sec	
Scale Factor Variation with Temp. 感度温度変動	-1.0		+1.0	%	Over the specified Operating Temp. Range
Bias(23degC) ゼロ点(23℃)	-0.02	0.00	+0.02	V	
Bias Variation with Temp. ゼロ点温度変動	-1		+ 1	deg/sec	Over the specified Operating Temp. Range
	-0.017		+ 0.017	rad/sec	
Non Linearity 非直線性			0.1	% of FS.	
Quiescent Noise 静止ノイズ			0.030	deg/sec·rms	3~30Hz
			5.24*10 ⁻⁴	rad/sec·rms	
Bandwidth 帯域	30	55		Hz	Bandwidth to - 3dB point
Cross Axis Sensitivity 他軸感度			2	%	
Power up Time 起動時間			0.5	sec	
Current Dissipation 消費電流			100	mA	
Inrush Current 突入電流			200	mA	
Reference output 基準電圧出力	2.380	2.400	2.420	V	w.r.t. GND Over the specified Operating Temp. Range
Output Impedance 出力インピーダンス	80	100	120	ohm	Rate & Ref
Minimum output current 最小出力電流	500			uA	Rate & Ref
Angular Random Walk アングラランダムウォーク			0.1	deg/h ^{0.5}	Determined using Allan Variance method
			0.0017	rad/h ^{0.5}	
Bias Instability バイアスインスタビリティ			3.0	deg/h	Determined using Allan Variance method
			0.053	rad/h	

	Name	Parameter	Min 最小値	Typ 代表値	Max 最大値	Unit 単位	Notes 備考
Auxiliary Output Signals 補助出力	FRQ	Resonating Ring Frequency 周波数	27.4	28.0	28.6	kHz	Output Impedance; 1kohm
		Frequency Temperature Coefficient 周波数の 温度係数	-0.86	-0.80	-0.74	Hz/degC	
	TMP	Temperature Sensor Scale Factor 温度センサ 温度係数	-12.60	-11.77	-11.00	mV/degC	Output Impedance; 470ohm See LM20B (NS) spec.

4. Output pins / 出力

Connector: IL-S-8P-S2L2-EF (JAE) /コネクタ: IL-S-8P-S2L2-EF (JAE)
(WEB site: <http://www.jae.co.jp/e-top/index.html>)

Pin Number	Name	Description
1	GND	Power ground, Electrically connected to the housing internally
2	+5V	Power input
3	Rate	Rate output with respect to REF
4	REF	Reference voltage. Datum for Rate & TMP
5	TMP	Temperature output with respect to REF
6	D.N.C.	Do Not Connect. Leave unconnected for proper operation.
7	FRQ	Resonating Ring Frequency output
8	N.C.	No Connection. Leave unconnected for correct operation.

5. SOLDERING / 半田付け

The product must not be subjected to temperatures above the recommended maximum storage temperature (e.g. solder reflow chamber) at any time. 本製品を何時も最高保存温度以上の環境（例えば半田リフロー内）に置くべきではありません。

6. NOTE / 注意事項

Do not drop onto a hard surface from a height exceeding 300mm

硬い表面に300mm以上の高さから落下させないように取り扱いにご注意ください。

The specifications mentioned in this publication are subject to change without notice.

本資料の掲載項目は製品の改良等により予告無しに変更される事があります。

Fig.1 Dimentions (外形寸法図) Not to Scale

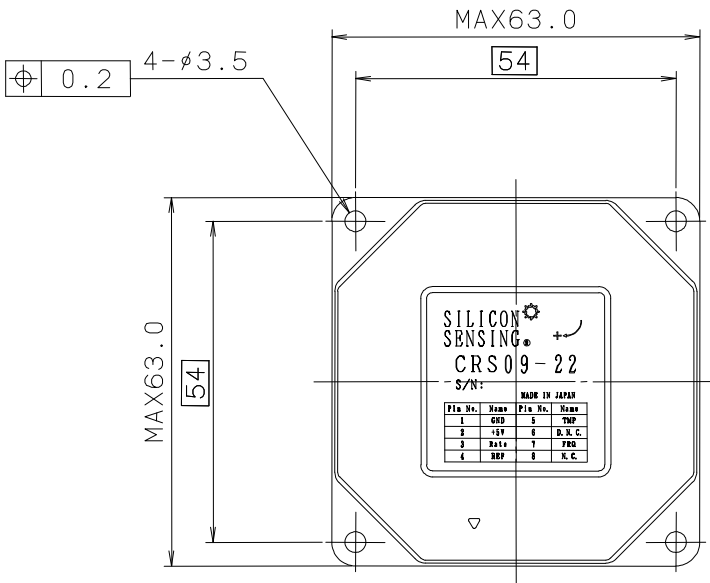

重量 : 60g
mass

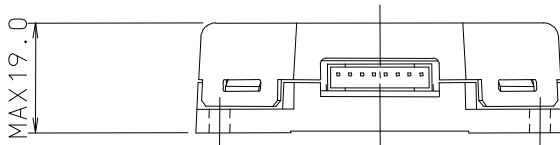

Fig.2 Typical connection (接続例)

